

Thermodynamics: An Engineering Approach
Fifth Edition in SI Units
Yunus A. Cengel, Michael A. Boles
McGraw-Hill, 2006



Chapter 2

ENERGY, ENERGY TRANSFER, AND GENERAL ENERGY ANALYSIS

Mechanical Engineering Dept.
University of Diyala

Objectives

- Introduce the concept of energy and define its various forms.
- Discuss the nature of internal energy.
- Define the concept of heat and the terminology associated with energy transfer by heat.
- Discuss the three mechanisms of heat transfer: conduction, convection, and radiation.
- Define the concept of work, including electrical work and several forms of mechanical work.
- Introduce the first law of thermodynamics, energy balances, and mechanisms of energy transfer to or from a system.
- Determine that a fluid flowing across a control surface of a control volume carries energy across the control surface in addition to any energy transfer across the control surface that may be in the form of heat and/or work.
- Define energy conversion efficiencies.
- Discuss the implications of energy conversion on the environment.

INTRODUCTION

- If we take the entire **room—including the air and the refrigerator (or fan)**—as the system, which is an adiabatic closed system since the room is well-sealed and well-insulated, the only energy interaction involved is the electrical energy crossing the system boundary and entering the room.
- As a result of the conversion of electric energy consumed by the device to heat, **the room temperature will rise.**



A fan running in a well-sealed and well-insulated room will raise the temperature of air in the room.

A refrigerator operating with its door open in a well-sealed and well-insulated room

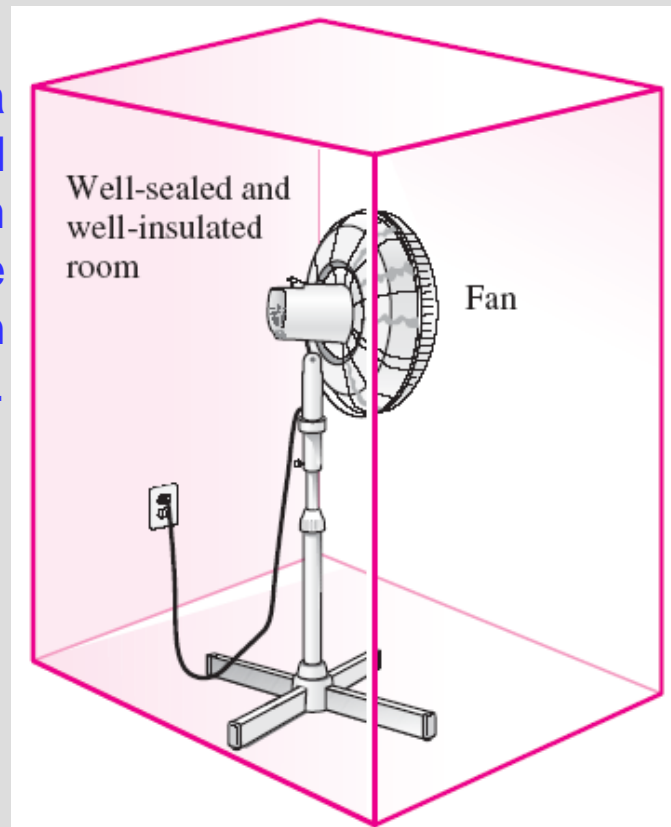

FORMS OF ENERGY

- Energy can exist in numerous forms such as thermal, mechanical, kinetic, potential, electric, magnetic, chemical, and nuclear, and their sum constitutes the **total energy, E** of a system.
- Thermodynamics deals only with the **change** of the total energy.
- **Macroscopic forms of energy:** Those a system possesses as a whole with respect to some outside reference frame, such as kinetic and potential energies.
- **Microscopic forms of energy:** Those related to the molecular structure of a system and the degree of the molecular activity.
- **Internal energy, U :** The sum of all the microscopic forms of energy.
- **Kinetic energy, KE:** The energy that a system possesses as a result of its motion relative to some reference frame.
- **Potential energy, PE:** The energy that a system possesses as a result of its elevation in a gravitational field.



The macroscopic energy of an object changes with velocity and elevation.

$$\text{KE} = m \frac{V^2}{2} \quad (\text{kJ}) \quad \text{Kinetic energy}$$

$$\text{ke} = \frac{V^2}{2} \quad (\text{kJ/kg}) \quad \text{Kinetic energy per unit mass}$$

$$\text{PE} = mgz \quad (\text{kJ}) \quad \text{Potential energy}$$

$$\text{pe} = gz \quad (\text{kJ/kg}) \quad \text{Potential energy per unit mass}$$

$$E = U + \text{KE} + \text{PE} = U + m \frac{V^2}{2} + mgz \quad (\text{kJ}) \quad \text{Total energy of a system}$$

$$e = u + \text{ke} + \text{pe} = u + \frac{V^2}{2} + gz \quad (\text{kJ/kg}) \quad \text{Energy of a system per unit mass}$$

$$e = \frac{E}{m} \quad (\text{kJ/kg}) \quad \text{Total energy per unit mass}$$

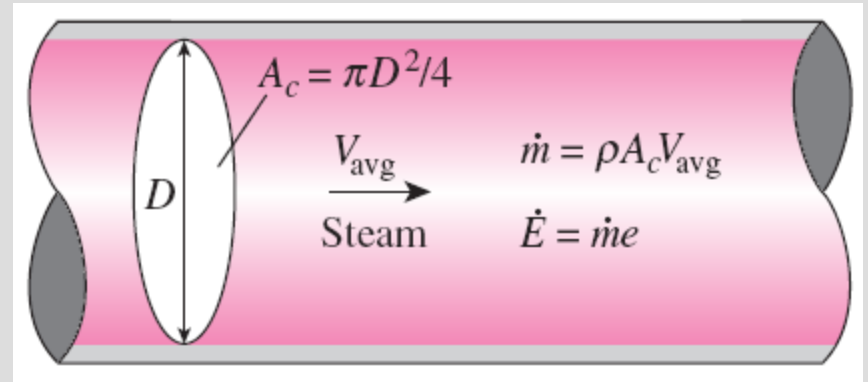

Mass flow rate

$$\dot{m} = \rho \dot{V} = \rho A_c V_{\text{avg}} \quad (\text{kg/s})$$

Energy flow rate

$$\dot{E} = \dot{m} e \quad (\text{kJ/s or kW})$$

Some Physical Insight to Internal Energy

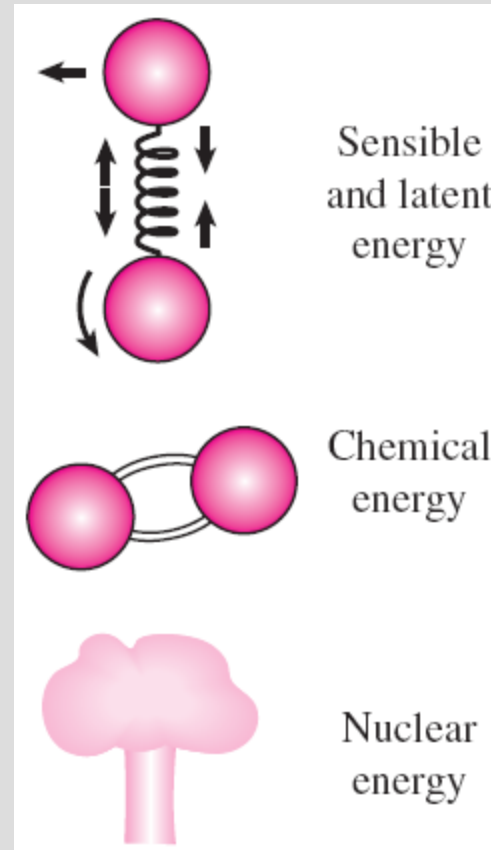
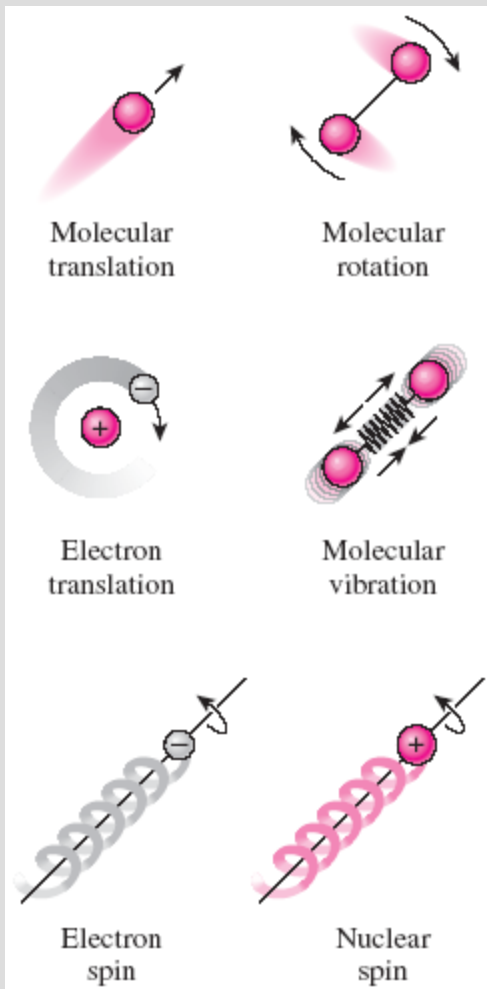

The internal energy of a system is the sum of all forms of the microscopic energies.

Sensible energy: The portion of the internal energy of a system associated with the kinetic energies of the molecules.

Latent energy: The internal energy associated with the phase of a system.

Chemical energy: The internal energy associated with the atomic bonds in a molecule.

Nuclear energy: The tremendous amount of energy associated with the strong bonds within the nucleus of the atom itself.

The various forms of microscopic energies that make up *sensible* energy.

Thermal = Sensible + Latent

Internal = Sensible + Latent + Chemical + Nuclear

- The total energy of a system, can be *contained* or *stored* in a system, and thus can be viewed as the **static forms of energy**.
- The forms of energy not stored in a system can be viewed as the **dynamic forms of energy** or as **energy interactions**.
- The dynamic forms of energy are recognized at the system boundary as they cross it, and they represent the energy gained or lost by a system during a process.
- The only two forms of energy interactions associated with a closed system are **heat transfer** and **work**.
- **The difference between heat transfer and work:** An energy interaction is heat transfer if its driving force is a temperature difference. Otherwise it is work.

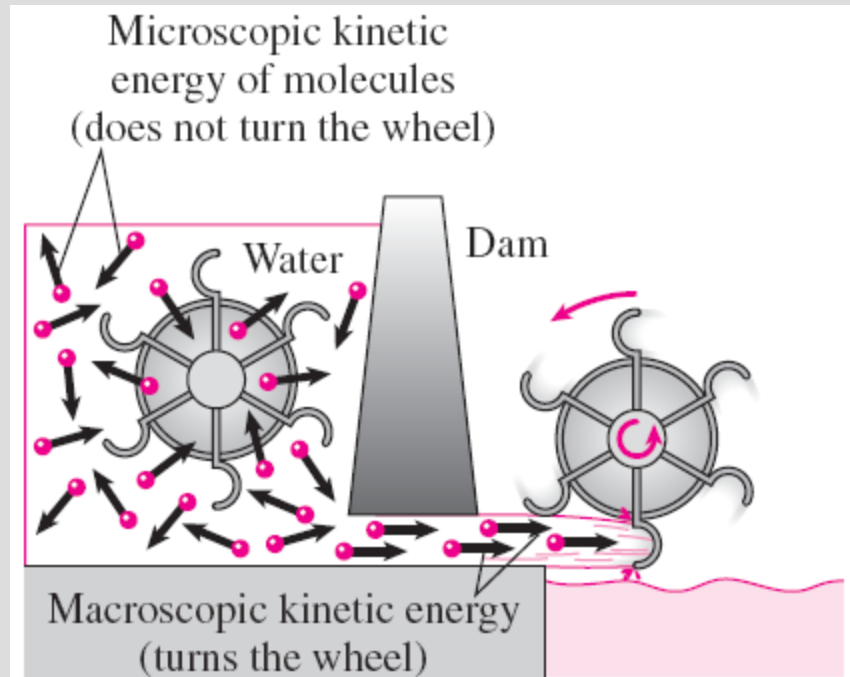

FIGURE 2-7

The *macroscopic* kinetic energy is an organized form of energy and is much more useful than the disorganized *microscopic* kinetic energies of the molecules.

More on Nuclear Energy

- The best known **fission** reaction involves the split of the uranium atom (the U-235 isotope) into other elements and is commonly used to generate electricity in nuclear power plants (440 of them in 2004, generating 363,000 MW worldwide), to power nuclear submarines and aircraft carriers, and even to power spacecraft as well as building nuclear bombs.
- Nuclear energy by **fusion** is released when two small nuclei combine into a larger one.
- The uncontrolled fusion reaction was achieved in the early 1950s, but all the efforts since then to achieve controlled fusion by massive lasers, powerful magnetic fields, and electric currents to generate power have failed.

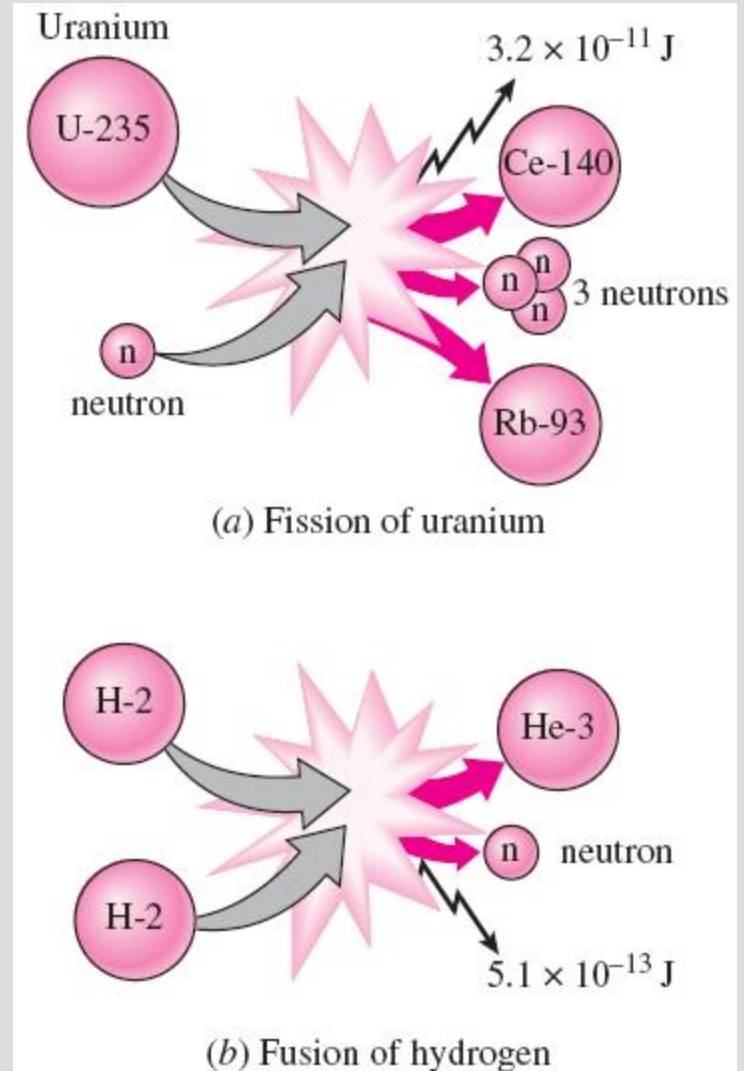

FIGURE 2-8

The fission of uranium and the fusion of hydrogen during nuclear reactions, and the release of nuclear energy.

Mechanical Energy

Mechanical energy: The form of energy that can be converted to mechanical work completely and directly by an ideal mechanical device such as an ideal turbine.

Kinetic and potential energies: The familiar forms of mechanical energy.

$$e_{\text{mech}} = \frac{P}{\rho} + \frac{V^2}{2} + gz$$

Mechanical energy of a flowing fluid per unit mass

$$\dot{E}_{\text{mech}} = \dot{m}e_{\text{mech}} = \dot{m} \left(\frac{P}{\rho} + \frac{V^2}{2} + gz \right)$$

Rate of mechanical energy of a flowing fluid

Mechanical energy change of a fluid during incompressible flow per unit mass

$$\Delta e_{\text{mech}} = \frac{P_2 - P_1}{\rho} + \frac{V_2^2 - V_1^2}{2} + g(z_2 - z_1) \quad (\text{kJ/kg})$$

Rate of mechanical energy change of a fluid during incompressible flow

$$\Delta \dot{E}_{\text{mech}} = \dot{m} \Delta e_{\text{mech}} = \dot{m} \left(\frac{P_2 - P_1}{\rho} + \frac{V_2^2 - V_1^2}{2} + g(z_2 - z_1) \right) \quad (\text{kW})$$



FIGURE 2-10

Mechanical energy is a useful concept for flows that do not involve significant heat transfer or energy conversion, such as the flow of gasoline from an underground tank into a car.

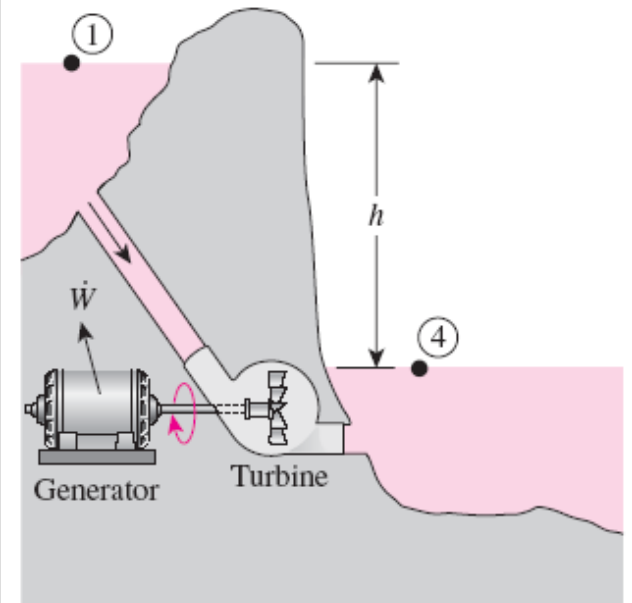

$$\dot{W}_{\max} = \dot{m}\Delta e_{\text{mech}} = \dot{m}g(z_1 - z_4) = \dot{m}gh$$

since $P_1 = P_4 = P_{\text{atm}}$ and $V_1 = V_4 = 0$

(a)

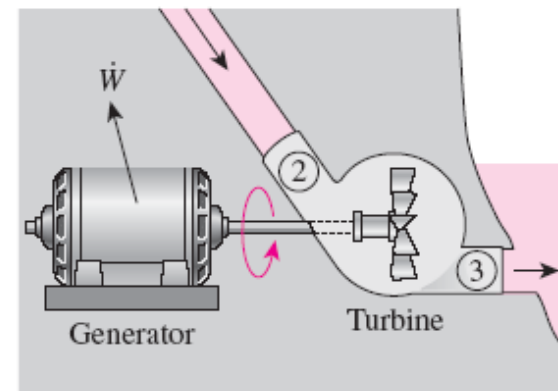

$$\dot{W}_{\max} = \dot{m}\Delta e_{\text{mech}} = \dot{m} \frac{(P_2 - P_3)}{\rho} = \dot{m} \frac{\Delta P}{\rho}$$

since $V_2 = V_3$ and $z_2 = z_3$

(b)

FIGURE 2-11

Mechanical energy is illustrated by an ideal hydraulic turbine coupled with an ideal generator. In the absence of irreversible losses, the maximum produced power is proportional to (a) the change in water surface elevation from the upstream to the downstream reservoir or (b) (close-up view) the drop in water pressure from just upstream to just downstream of the turbine.

ENERGY TRANSFER BY HEAT

Heat: The form of energy that is transferred between two systems (or a system and its surroundings) by virtue of a temperature difference.

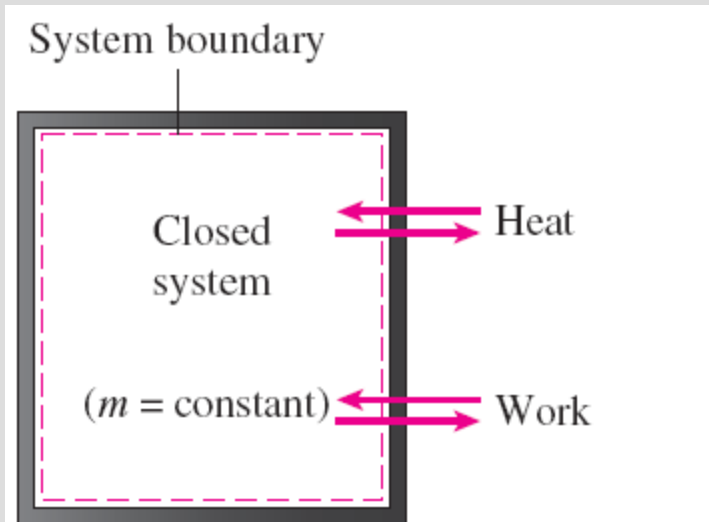

FIGURE 2-13

Energy can cross the boundaries of a closed system in the form of heat and work.

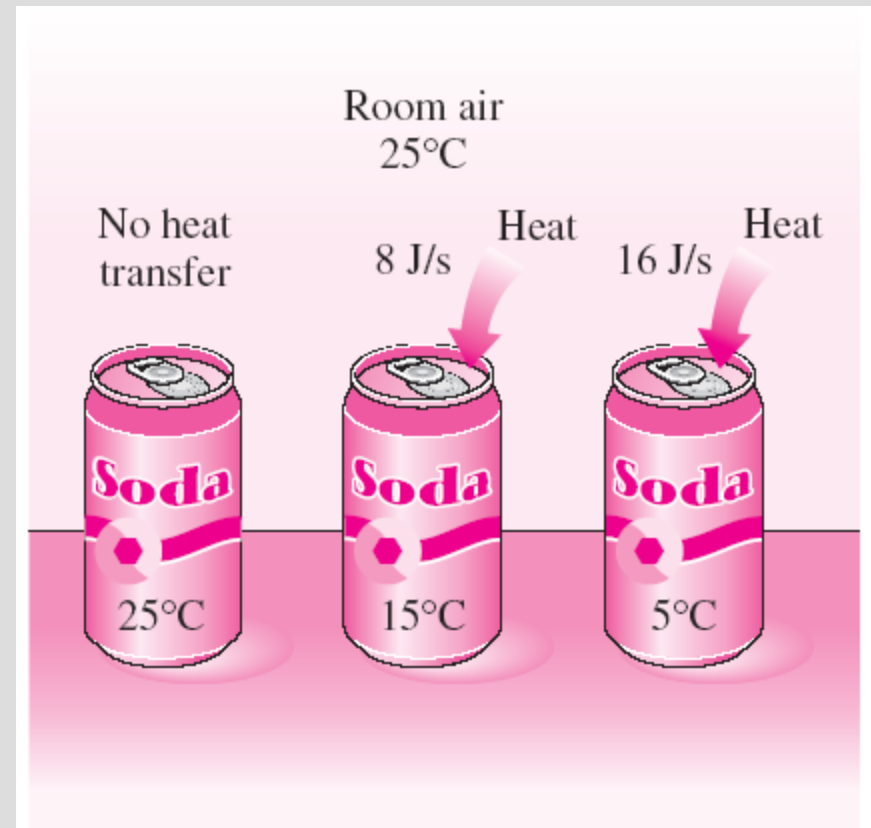

FIGURE 2-14

Temperature difference is the driving force for heat transfer. The larger the temperature difference, the higher is the rate of heat transfer.

$$q = \frac{Q}{m} \quad (\text{kJ/kg})$$

Heat transfer per unit mass

$$Q = \dot{Q} \Delta t \quad (\text{kJ})$$

Amount of heat transfer when heat transfer rate is constant

$$Q = \int_{t_1}^{t_2} \dot{Q} dt \quad (\text{kJ})$$

Amount of heat transfer when heat transfer rate changes with time

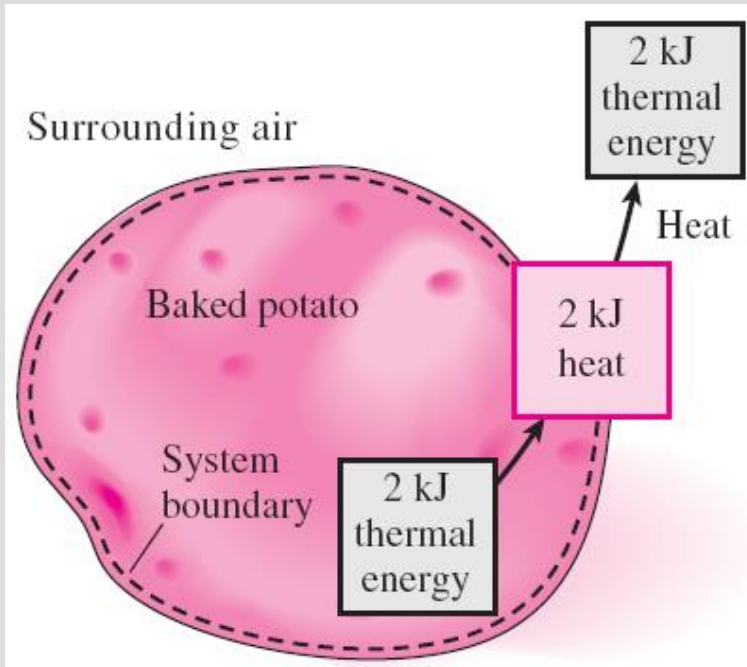
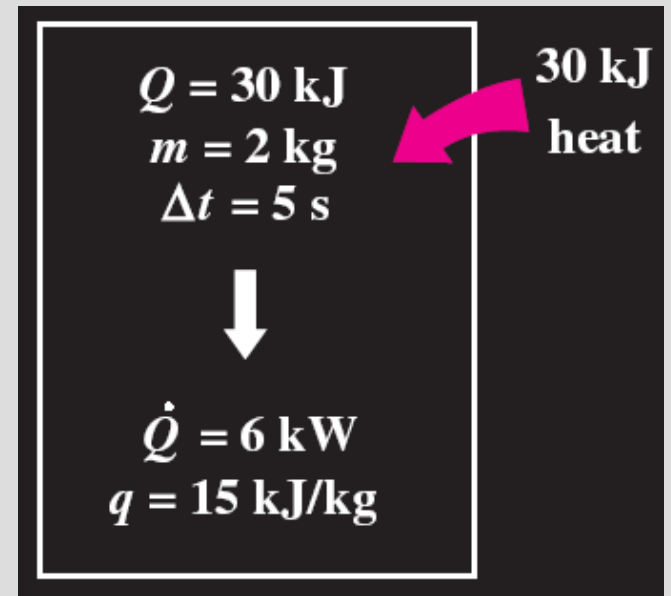

Energy is recognized as heat transfer only as it crosses the system boundary.

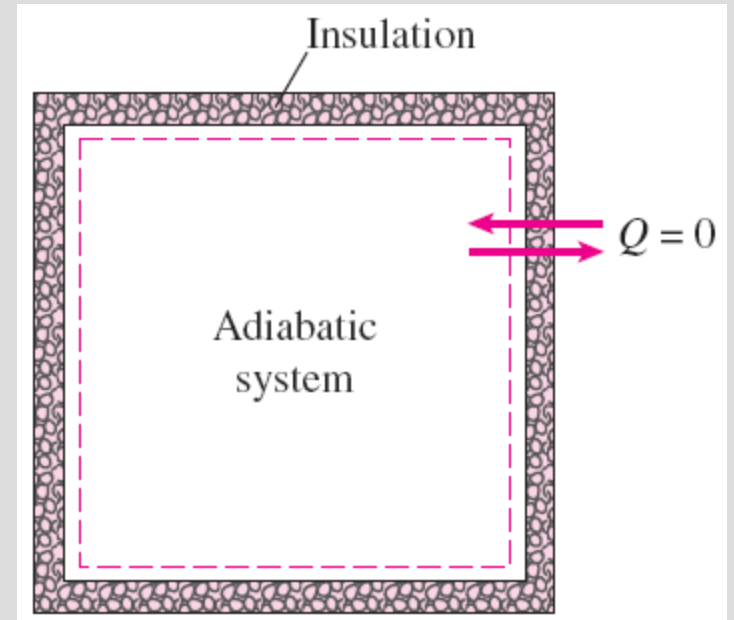

During an adiabatic process, a system exchanges no heat with its surroundings.

Historical Background on Heat

- **Kinetic theory:** Treats molecules as tiny balls that are in motion and thus possess kinetic energy.
- **Heat:** The energy associated with the random motion of atoms and molecules.

Heat transfer mechanisms:

- **Conduction:** The transfer of energy from the more energetic particles of a substance to the adjacent less energetic ones as a result of interaction between particles.
- **Convection:** The transfer of energy between a solid surface and the adjacent fluid that is in motion, and it involves the combined effects of conduction and fluid motion.
- **Radiation:** The transfer of energy due to the emission of electromagnetic waves (or photons).

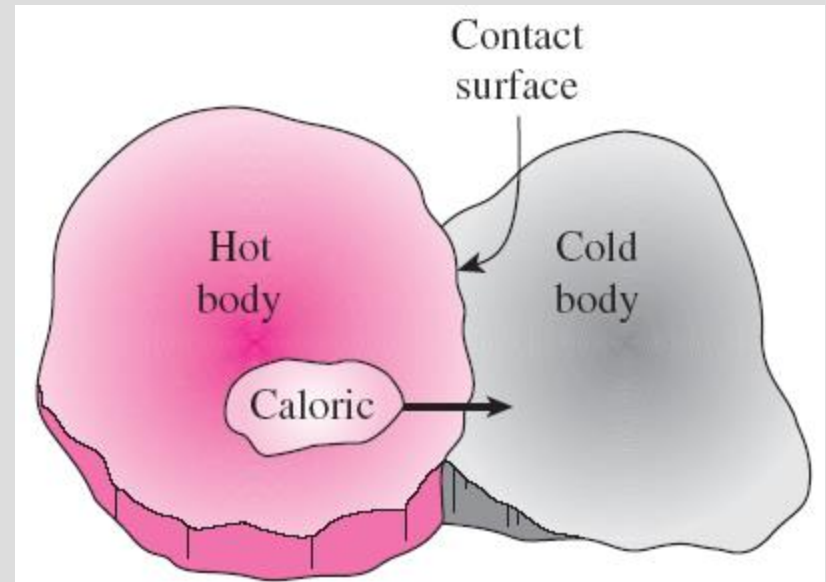

FIGURE 2-18

In the early nineteenth century, heat was thought to be an invisible fluid called the *caloric* that flowed from warmer bodies to the cooler ones.

ENERGY TRANSFER BY WORK

- **Work:** The energy transfer associated with a force acting through a distance.
 - ✓ **A rising piston, a rotating shaft, and an electric wire crossing the system boundaries** are all associated with work interactions
- **Formal sign convention:** *Heat transfer to a system and work done by a system are positive; heat transfer from a system and work done on a system are negative.*
- Alternative to sign convention is to use the subscripts **in** and **out** to indicate direction. **This is the primary approach in this text.**

$$w = \frac{W}{m} \quad (\text{kJ/kg})$$

Work done per unit mass

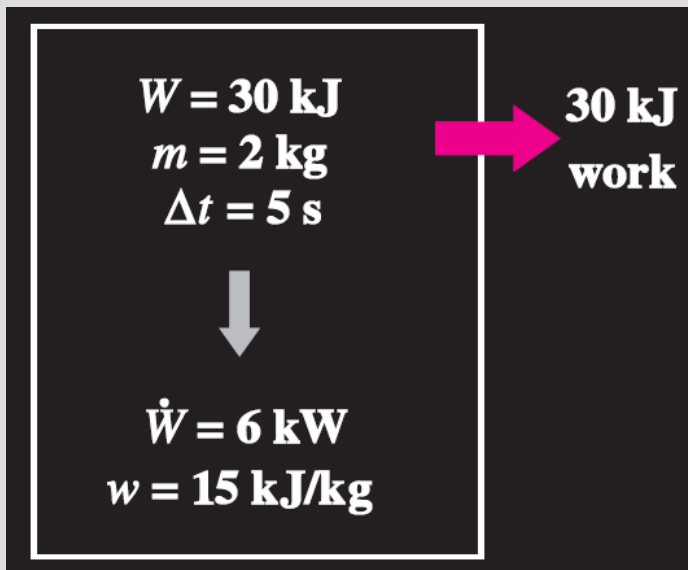

Power is the work done per unit time (kW)

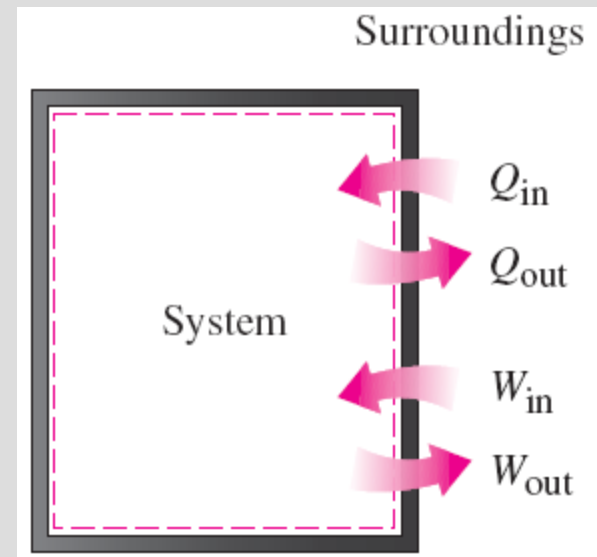

Specifying the directions of heat and work.

Heat vs. Work

- Both are recognized at the boundaries of a system as they cross the boundaries. That is, both heat and work are *boundary* phenomena.
- Systems possess energy, but not heat or work.
- Both are associated with a *process*, not a state.
- Unlike properties, heat or work has no meaning at a state.
- Both are *path functions* (i.e., their magnitudes depend on the path followed during a process as well as the end states).

Properties are point functions have exact differentials (d).

$$\int_1^2 dV = V_2 - V_1 = \Delta V$$

Path functions have inexact differentials (δ)

$$\int_1^2 \delta W = W_{12} \quad (\text{not } \Delta W)$$

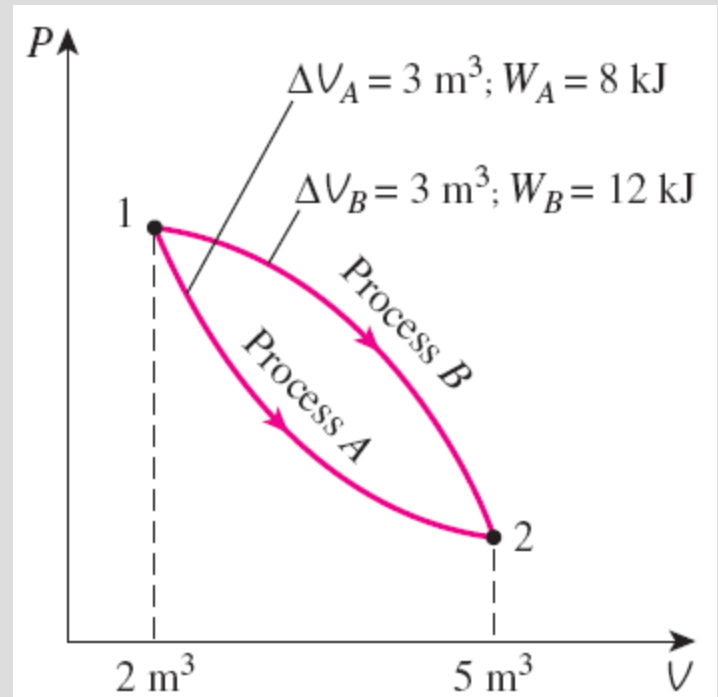

FIGURE 2-21

Properties are point functions; but heat and work are path functions (their magnitudes depend on the path followed).

Electrical Work

Electrical work

$$W_e = \mathbf{VN}$$

Electrical power

$$\dot{W}_e = \mathbf{VI} \quad (\text{W})$$

When potential difference and current change with time

$$W_e = \int_1^2 \mathbf{VI} dt \quad (\text{kJ})$$

When potential difference and current remain constant

$$W_e = \mathbf{VI} \Delta t \quad (\text{kJ})$$

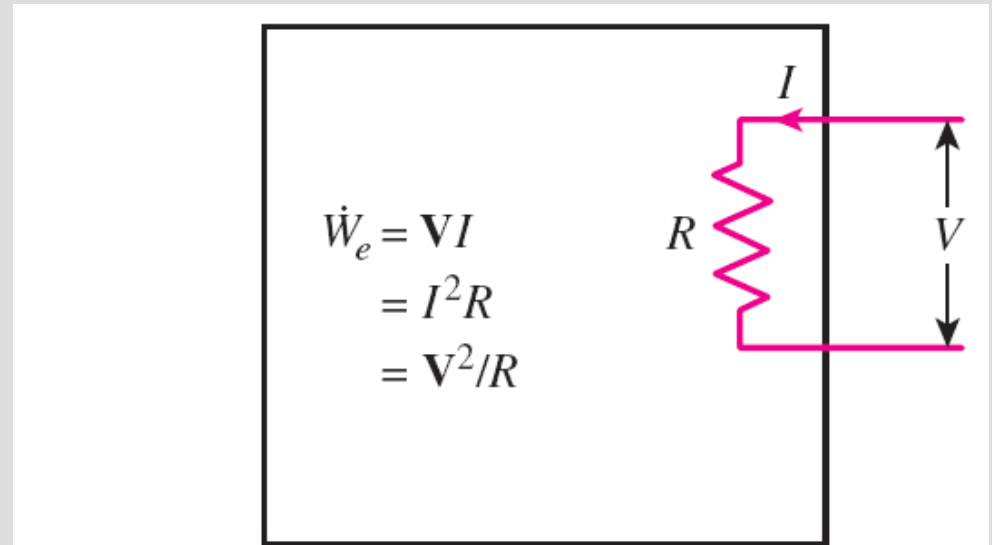

FIGURE 2–26

Electrical power in terms of resistance R , current I , and potential difference V .

MECHANICAL FORMS OF WORK

- There are two requirements for a work interaction between a system and its surroundings to exist:
 - ✓ there must be a **force** acting on the boundary.
 - ✓ the boundary must **move**.

Work = Force × Distance

$$W = Fs \quad (\text{kJ})$$

When force is not constant

$$W = \int_1^2 F ds \quad (\text{kJ})$$

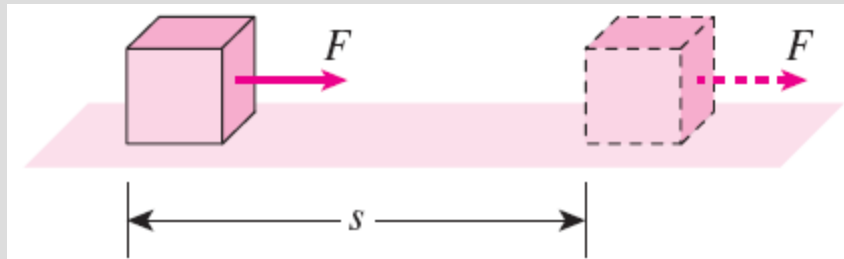

FIGURE 2-27

The work done is proportional to the force applied (F) and the distance traveled (s).



FIGURE 2-28

If there is no movement, no work is done.

Shaft Work

A force F acting through a moment arm r generates a torque T

$$T = Fr \quad \rightarrow \quad F = \frac{T}{r}$$

This force acts through a distance s $s = (2\pi r)n$

Shaft work

$$W_{\text{sh}} = Fs = \left(\frac{T}{r}\right)(2\pi rn) = 2\pi nT \quad (\text{kJ})$$

The power transmitted through the shaft is the shaft work done per unit time

$$\dot{W}_{\text{sh}} = 2\pi n\dot{T} \quad (\text{kW})$$

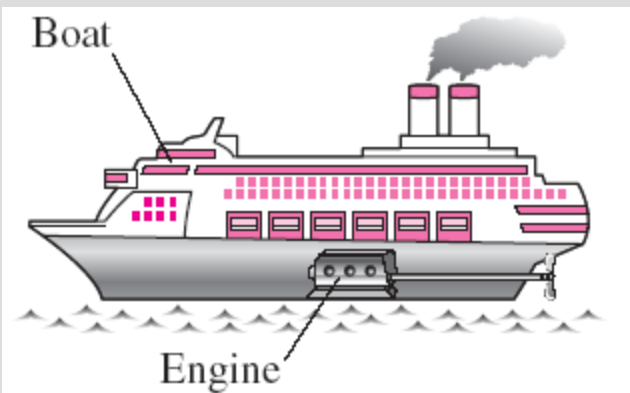

FIGURE 2-29

Energy transmission through rotating shafts is commonly encountered in practice.

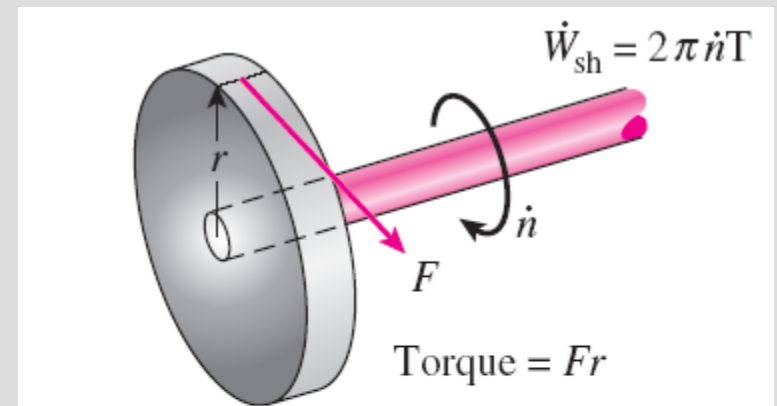

FIGURE 2-30

Shaft work is proportional to the torque applied and the number of revolutions of the shaft.

Spring Work

When the length of the spring changes by a differential amount dx under the influence of a force F , the work done is

$$\delta W_{\text{spring}} = F dx$$

For linear elastic springs, the displacement x is proportional to the force applied

$$F = kx \quad (\text{kN}) \quad k: \text{spring constant (kN/m)}$$

Substituting and integrating yield

$$W_{\text{spring}} = \frac{1}{2}k(x_2^2 - x_1^2) \quad (\text{kJ})$$

x_1 and x_2 : the initial and the final displacements

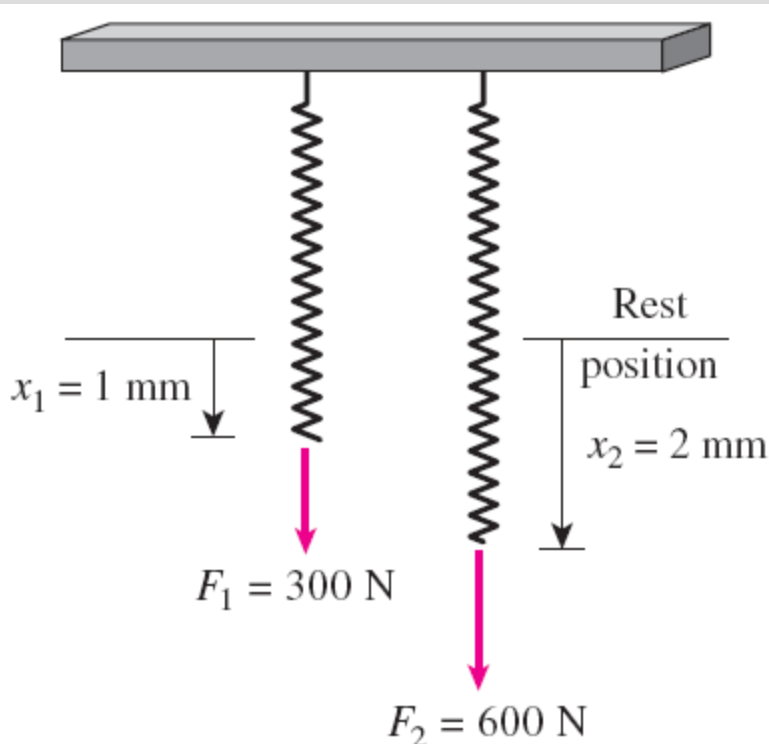

Elongation of a spring under the influence of a force.

The displacement of a linear spring doubles when the force is doubled.

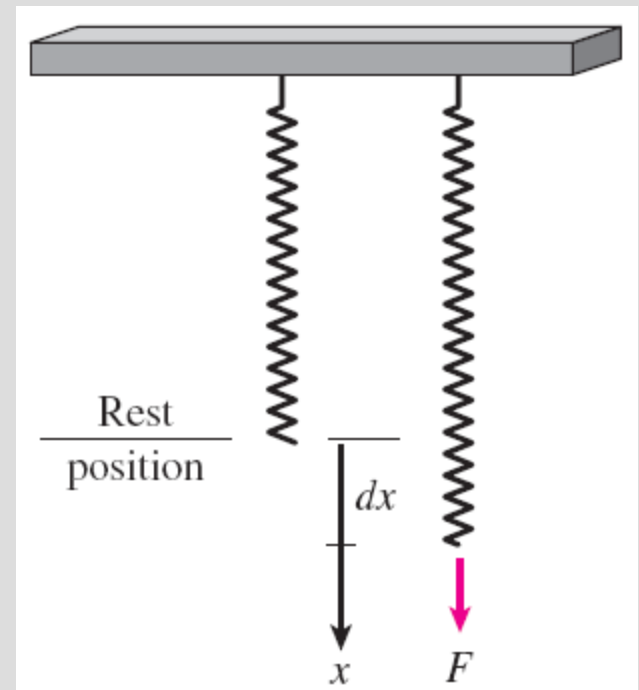

Work Done on Elastic Solid Bars

$$W_{\text{elastic}} = \int_1^2 F dx = \int_1^2 \sigma_n A dx \quad (\text{kJ})$$

Work Associated with the Stretching of a Liquid Film

$$W_{\text{surface}} = \int_1^2 \sigma_s dA \quad (\text{kJ})$$

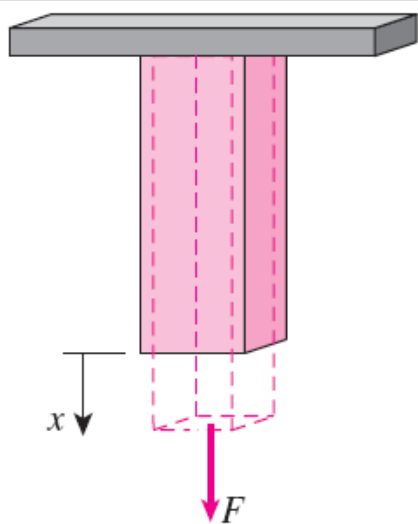

FIGURE 2-34

Solid bars behave as springs under the influence of a force.

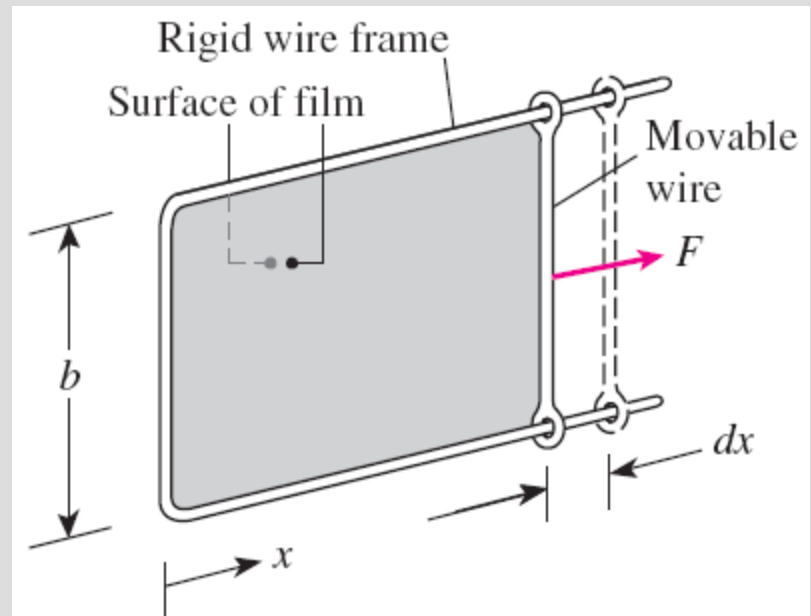

FIGURE 2-35

Stretching a liquid film with a movable wire.

Work Done to Raise or to Accelerate a Body

1. The work transfer needed to raise a body is equal to the change in the potential energy of the body.
2. The work transfer needed to accelerate a body is equal to the change in the kinetic energy of the body.

Nonmechanical Forms of Work

Electrical work: The generalized force is the *voltage* (the electrical potential) and the generalized displacement is the *electrical charge*.

Magnetic work: The generalized force is the *magnetic field strength* and the generalized displacement is the total *magnetic dipole moment*.

Electrical polarization work: The generalized force is the *electric field strength* and the generalized displacement is the *polarization of the medium*.

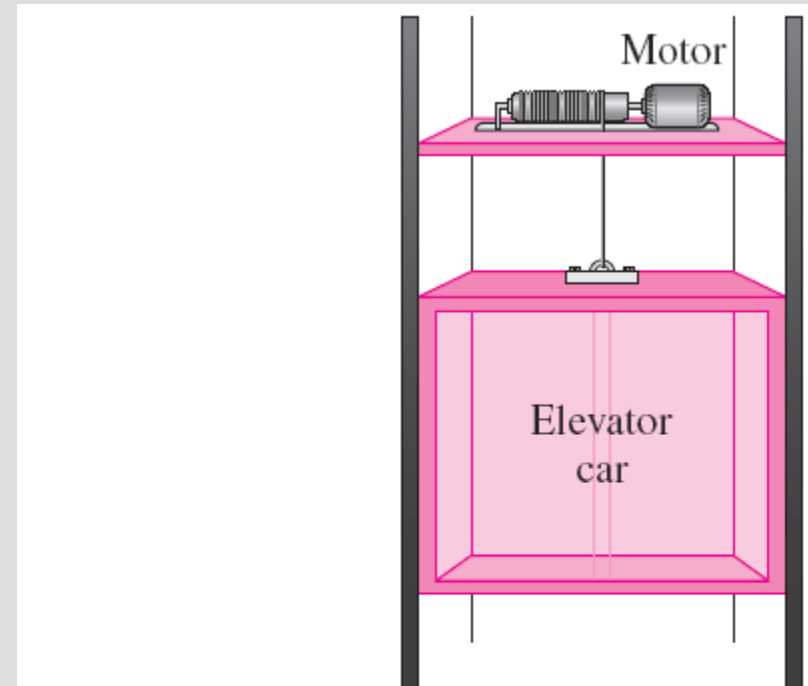
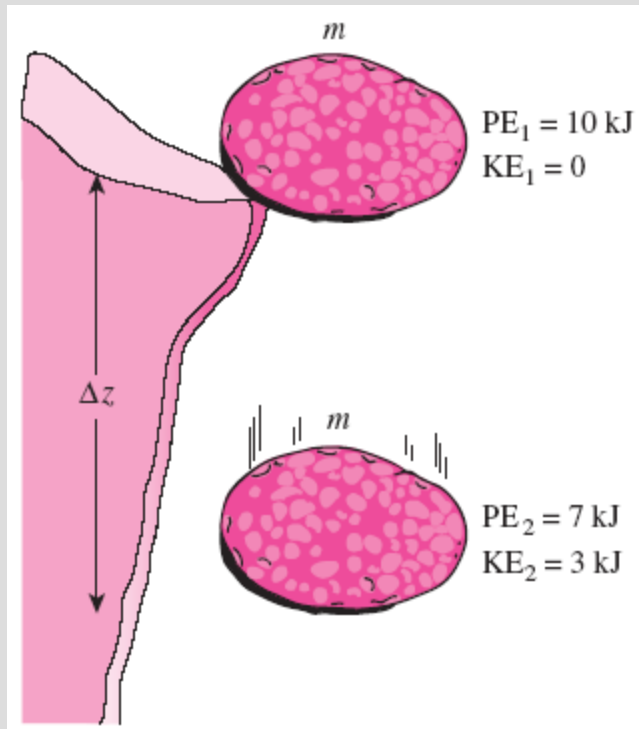

FIGURE 2–36

The energy transferred to a body while being raised is equal to the change in its potential energy.

THE FIRST LAW OF THERMODYNAMICS

- The *first law of thermodynamics (the conservation of energy principle)* provides a sound basis for studying the relationships among the various forms of energy and energy interactions.
- The first law states that *energy can be neither created nor destroyed during a process; it can only change forms.*
- **The First Law:** For all adiabatic processes between two specified states of a closed system, the net work done is the same regardless of the nature of the closed system and the details of the process.



Energy cannot be created or destroyed; it can only change forms.

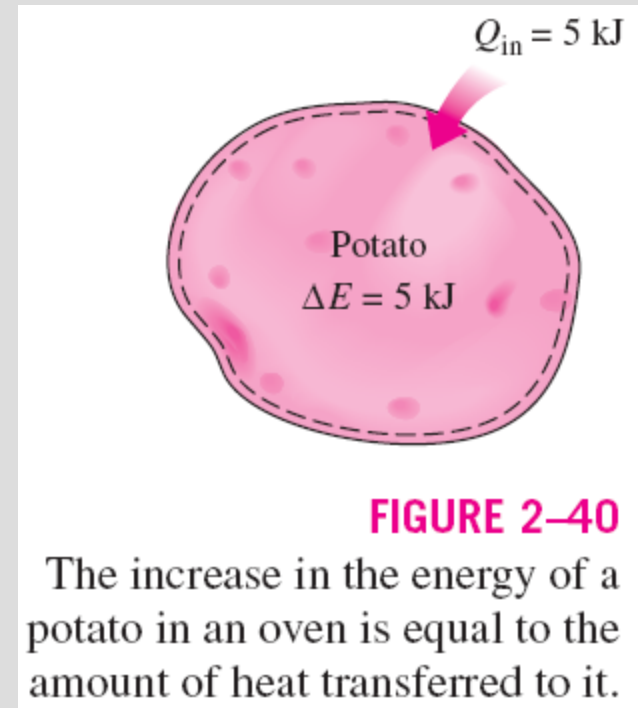

FIGURE 2-40

The increase in the energy of a potato in an oven is equal to the amount of heat transferred to it.

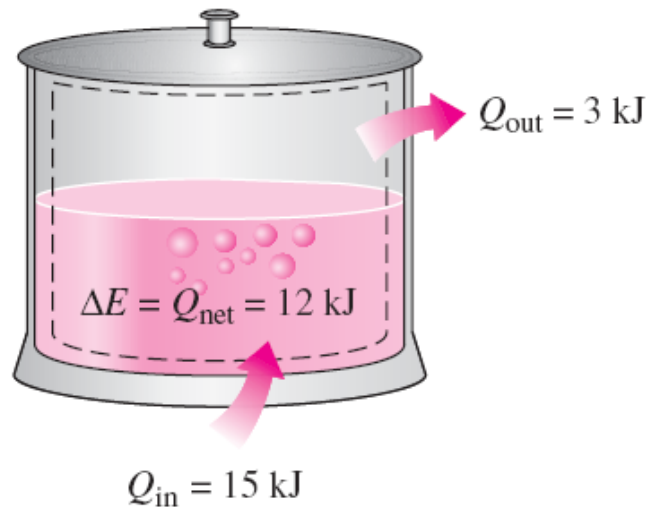

FIGURE 2-41

In the absence of any work interactions, the energy change of a system is equal to the net heat transfer.

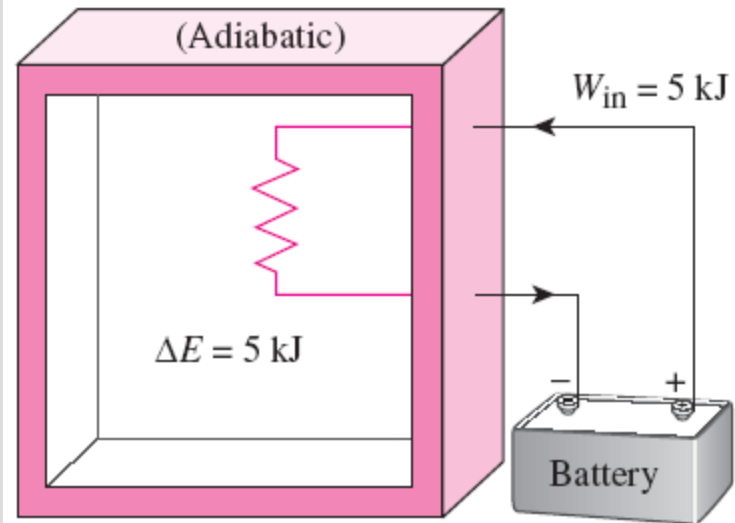

FIGURE 2-42

The work (electrical) done on an adiabatic system is equal to the increase in the energy of the system.

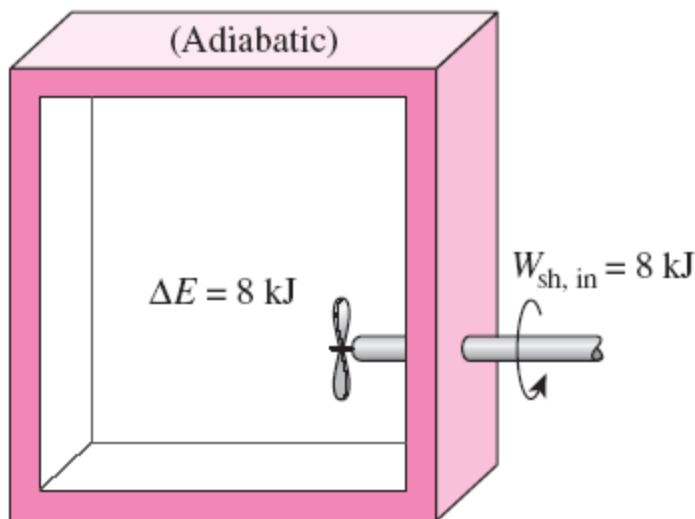

FIGURE 2-43

The work (shaft) done on an adiabatic system is equal to the increase in the energy of the system.

Energy Balance

The net change (increase or decrease) in the total energy of the system during a process is equal to the difference between the total energy entering and the total energy leaving the system during that process.

$$\left(\begin{array}{c} \text{Total energy} \\ \text{entering the system} \end{array} \right) - \left(\begin{array}{c} \text{Total energy} \\ \text{leaving the system} \end{array} \right) = \left(\begin{array}{c} \text{Change in the total} \\ \text{energy of the system} \end{array} \right)$$

$$E_{\text{in}} - E_{\text{out}} = \Delta E_{\text{system}}$$

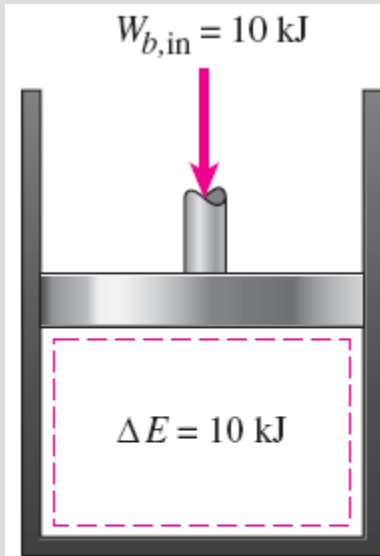

(Adiabatic)

FIGURE 2-44

The work (boundary) done on an adiabatic system is equal to the increase in the energy of the system.

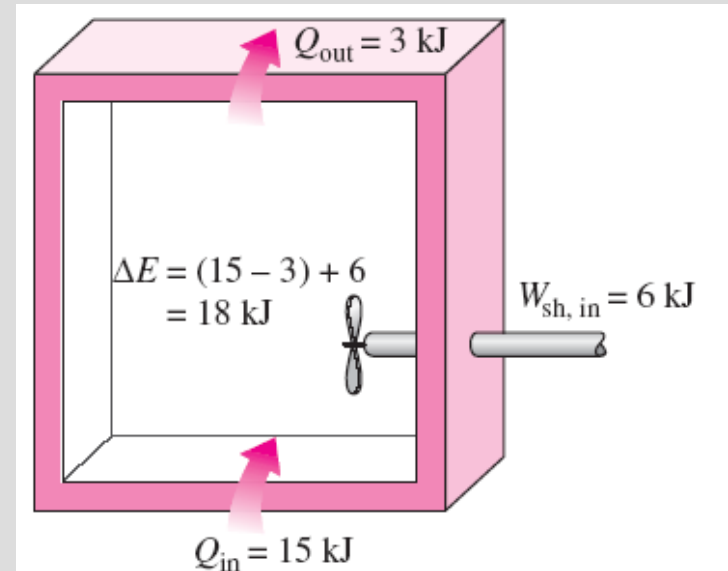

FIGURE 2-45

The energy change of a system during a process is equal to the *net* work and heat transfer between the system and its surroundings.

Energy Change of a System, ΔE_{system}

Energy change = Energy at final state – Energy at initial state

$$\Delta E_{\text{system}} = E_{\text{final}} - E_{\text{initial}} = E_2 - E_1$$

$$\Delta E = \Delta U + \Delta \text{KE} + \Delta \text{PE}$$

Internal, kinetic, and potential energy changes

$$\Delta U = m(u_2 - u_1)$$

$$\Delta \text{KE} = \frac{1}{2} m(V_2^2 - V_1^2)$$

$$\Delta \text{PE} = mg(z_2 - z_1)$$

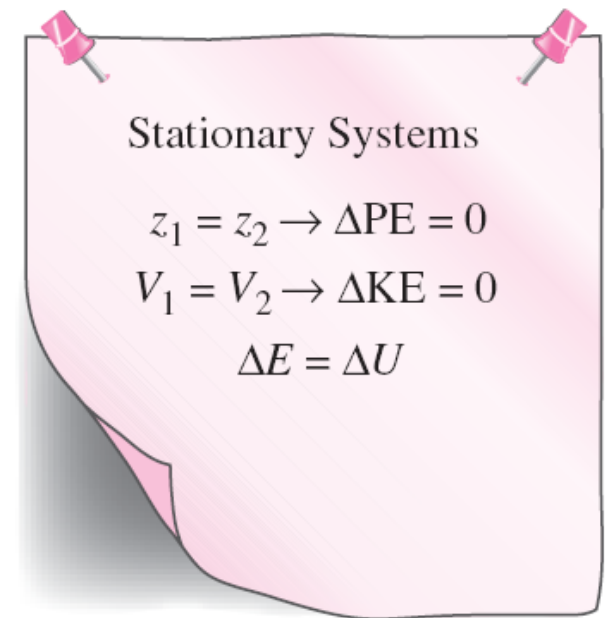

FIGURE 2-46

For stationary systems, $\Delta \text{KE} = \Delta \text{PE} = 0$; thus $\Delta E = \Delta U$.

Mechanisms of Energy Transfer, E_{in} and E_{out}

- Heat transfer
- Work transfer
- Mass flow

A closed mass involves only *heat transfer and work*.

$$E_{in} - E_{out} = (Q_{in} - Q_{out}) + (W_{in} - W_{out}) + (E_{mass,in} - E_{mass,out}) = \Delta E_{system}$$

$$\underbrace{E_{in} - E_{out}}_{\text{Net energy transfer by heat, work, and mass}} = \underbrace{\Delta E_{system}}_{\text{Change in internal, kinetic, potential, etc., energies}} \quad (\text{kJ})$$

$$\underbrace{\dot{E}_{in} - \dot{E}_{out}}_{\text{Rate of net energy transfer by heat, work, and mass}} = \underbrace{dE_{system}/dt}_{\text{Rate of change in internal, kinetic, potential, etc., energies}} \quad (\text{kW})$$

$$Q = \dot{Q} \Delta t \quad (\text{kJ})$$

$$W = \dot{W} \Delta t$$

$$\Delta E = (dE/dt) \Delta t$$

$$e_{in} - e_{out} = \Delta e_{system} \quad (\text{kJ/kg})$$

$$\delta E_{in} - \delta E_{out} = dE_{system} \quad \delta e_{in} - \delta e_{out} = de_{system}$$

$$\dot{W}_{net,out} = \dot{Q}_{net,in} \quad (\text{for a cycle})$$

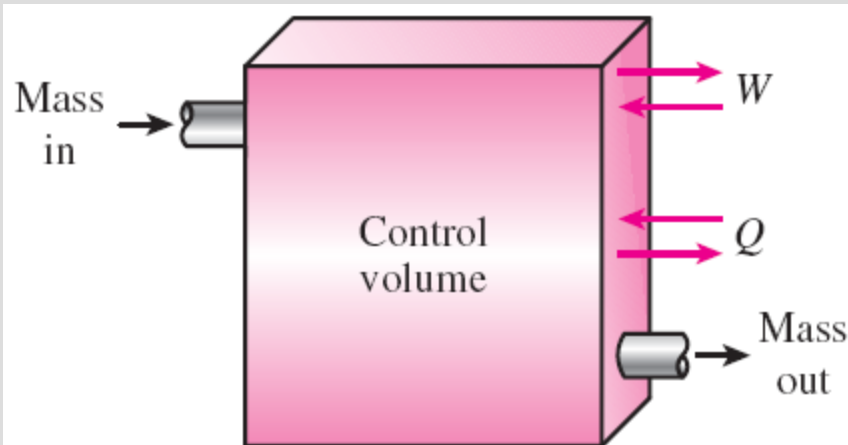

The energy content of a control volume can be changed by mass flow as well as heat and work interactions.

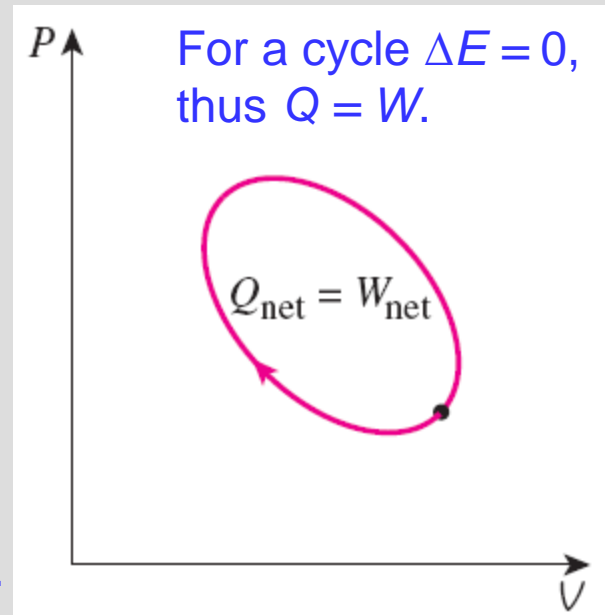

ENERGY CONVERSION EFFICIENCIES

Efficiency is one of the most frequently used terms in thermodynamics, and it indicates how well an energy conversion or transfer process is accomplished.

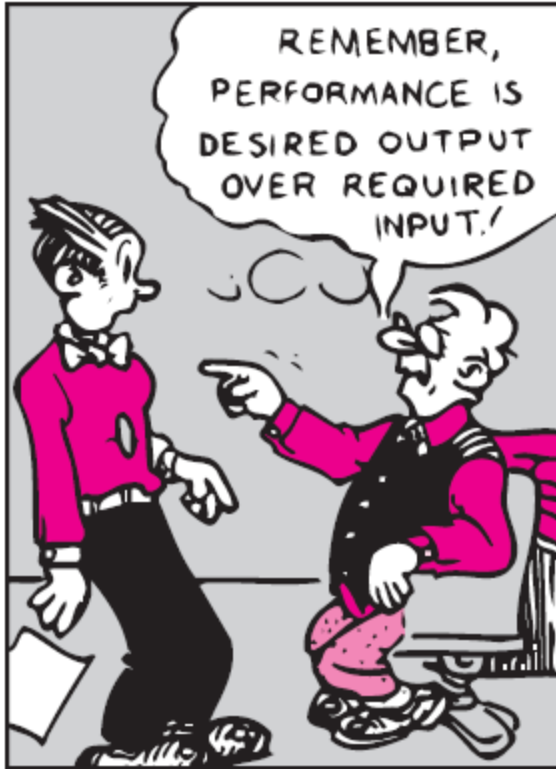

FIGURE 2-54

The definition of performance is not limited to thermodynamics only.

$$\text{Performance} = \frac{\text{Desired output}}{\text{Required input}}$$

Efficiency of a water heater: The ratio of the energy delivered to the house by hot water to the energy supplied to the water heater.

Type	Efficiency
Gas, conventional	55%
Gas, high-efficiency	62%
Electric, conventional	90%
Electric, high-efficiency	94%



Water heater

$$\eta_{\text{combustion}} = \frac{Q}{HV} = \frac{\text{Amount of heat released during combustion}}{\text{Heating value of the fuel burned}}$$

Heating value of the fuel: The amount of heat released when a unit amount of fuel at room temperature is completely burned and the combustion products are cooled to the room temperature.

Lower heating value (LHV): When the water leaves as a vapor.

Higher heating value (HHV): When the water in the combustion gases is completely condensed and thus the heat of vaporization is also recovered.

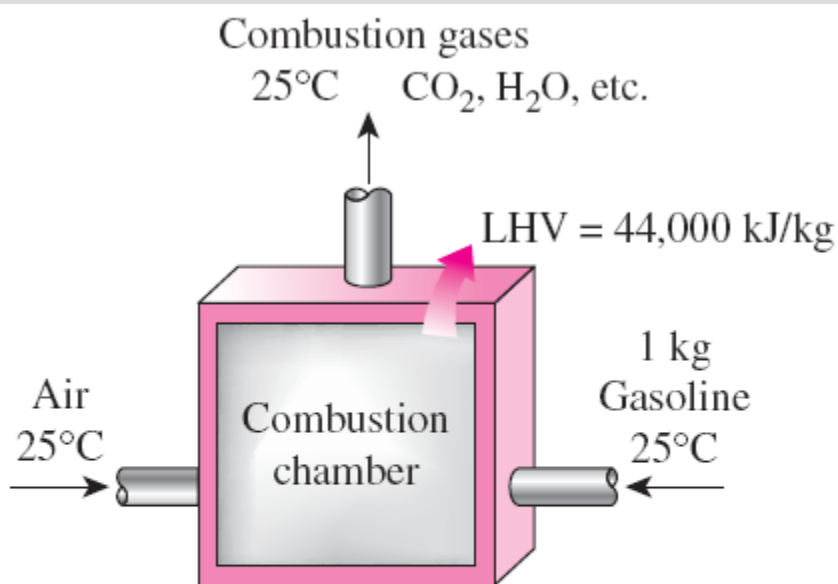

FIGURE 2-56

The definition of the heating value of gasoline.

The efficiency of space heating systems of residential and commercial buildings is usually expressed in terms of the **annual fuel utilization efficiency (AFUE)**, which accounts for the combustion efficiency as well as other losses such as heat losses to unheated areas and start-up and cool down losses.

- **Generator:** A device that converts mechanical energy to electrical energy.
- **Generator efficiency:** The ratio of the electrical power output to the mechanical power input.
- **Thermal efficiency of a power plant:** The ratio of the net electrical power output to the rate of fuel energy input.

Overall efficiency of a power plant

TABLE 2-1

The efficacy of different lighting systems

Type of lighting	Efficacy, lumens/W
<i>Combustion</i>	
Candle	0.3
Kerosene lamp	1–2
<i>Incandescent</i>	
Ordinary	6–20
Halogen	15–35
<i>Fluorescent</i>	
Compact	40–87
Tube	60–120
<i>High-intensity discharge</i>	
Mercury vapor	40–60
Metal halide	65–118
High-pressure sodium	85–140
Low-pressure sodium	70–200
<i>Solid-State</i>	
LED	20–160
OLED	15–60
Theoretical limit	300*

$$\eta_{\text{overall}} = \eta_{\text{combustion}} \eta_{\text{thermal}} \eta_{\text{generator}} = \frac{\dot{W}_{\text{net,electric}}}{\text{HHV} \times \dot{m}_{\text{net}}}$$

Lighting efficacy:
The amount of light output in lumens per W of electricity consumed.

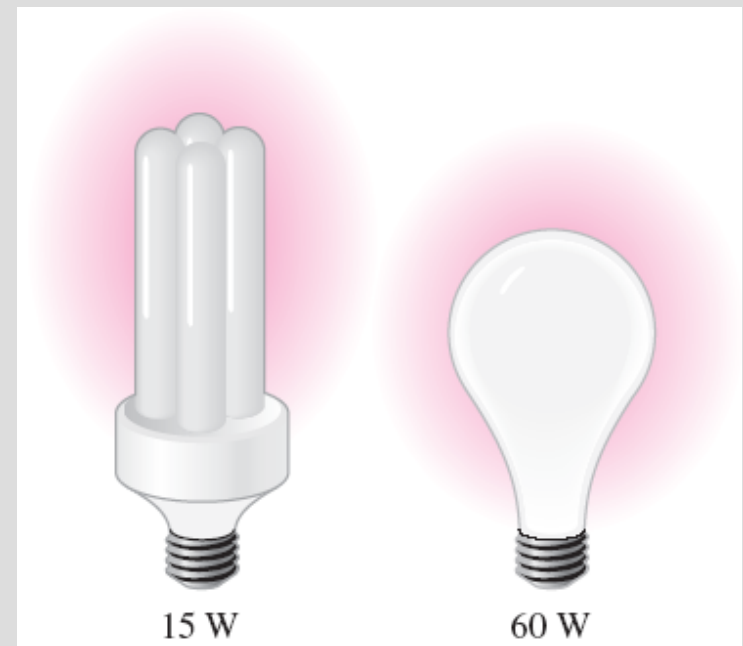

FIGURE 2-57

A 15-W compact fluorescent lamp provides as much light as a 60-W incandescent lamp.

TABLE 2-2

Energy costs of cooking a casserole with different appliances*

[From J. T. Amann, A. Wilson, and K. Ackerly, *Consumer Guide to Home Energy Savings*, 9th ed., American Council for an Energy-Efficient Economy, Washington, D.C., 2007, p. 163.]

Cooking appliance	Cooking temperature	Cooking time	Energy used	Cost of energy
Electric oven	350°F (177°C)	1 h	2.0 kWh	\$0.19
Convection oven (elect.)	325°F (163°C)	45 min	1.39 kWh	\$0.13
Gas oven	350°F (177°C)	1 h	0.112 therm	\$0.13
Frying pan	420°F (216°C)	1 h	0.9 kWh	\$0.09
Toaster oven	425°F (218°C)	50 min	0.95 kWh	\$0.09
Crockpot	200°F (93°C)	7 h	0.7 kWh	\$0.07
Microwave oven	"High"	15 min	0.36 kWh	\$0.03

*Assumes a unit cost of \$0.095/kWh for electricity and \$1.20/therm for gas.

- Using energy-efficient appliances **conserve energy**.
- It helps the **environment** by reducing the amount of pollutants emitted to the atmosphere during the combustion of fuel.
- The combustion of fuel produces
 - **carbon dioxide**, causes global warming
 - **nitrogen oxides** and **hydrocarbons**, cause smog
 - **carbon monoxide**, toxic
 - **sulfur dioxide**, causes acid rain.

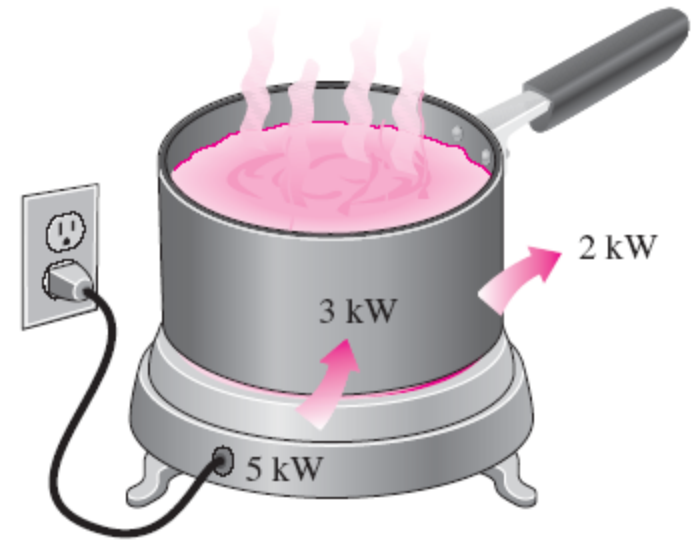

$$\text{Efficiency} = \frac{\text{Energy utilized}}{\text{Energy supplied to appliance}}$$

$$= \frac{3 \text{ kWh}}{5 \text{ kWh}} = 0.60$$

FIGURE 2-58

The efficiency of a cooking appliance represents the fraction of the energy supplied to the appliance that is transferred to the food.

Efficiencies of Mechanical and Electrical Devices

Mechanical efficiency

$$\eta_{\text{mech}} = \frac{\text{Mechanical energy output}}{\text{Mechanical energy input}} = \frac{E_{\text{mech,out}}}{E_{\text{mech,in}}} = 1 - \frac{E_{\text{mech,loss}}}{E_{\text{mech,in}}}$$

The effectiveness of the conversion process between the mechanical work supplied or extracted and the mechanical energy of the fluid is expressed by the **pump efficiency** and **turbine efficiency**,

$$\eta_{\text{pump}} = \frac{\text{Mechanical energy increase of the fluid}}{\text{Mechanical energy input}} = \frac{\Delta \dot{E}_{\text{mech,fluid}}}{\dot{W}_{\text{shaft,in}}} = \frac{\dot{W}_{\text{pump,u}}}{\dot{W}_{\text{pump}}}$$

$$\Delta \dot{E}_{\text{mech,fluid}} = \dot{E}_{\text{mech,out}} - \dot{E}_{\text{mech,in}}$$

$$\eta_{\text{turbine}} = \frac{\text{Mechanical energy output}}{\text{Mechanical energy decrease of the fluid}} = \frac{\dot{W}_{\text{shaft,out}}}{|\Delta \dot{E}_{\text{mech,fluid}}|} = \frac{\dot{W}_{\text{turbine}}}{\dot{W}_{\text{turbine,e}}}$$

$$|\Delta \dot{E}_{\text{mech,fluid}}| = \dot{E}_{\text{mech,in}} - \dot{E}_{\text{mech,out}}$$

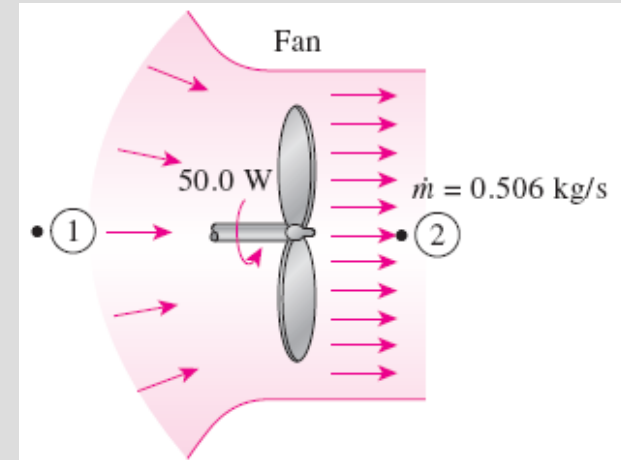

$$V_1 \times 0, V_2 = 12.1 \text{ m/s}$$

$$z_1 = z_2$$

$$P_1 \times P_{\text{atm}} \text{ and } P_2 \times P_{\text{atm}}$$

$$\begin{aligned} \eta_{\text{mech, fan}} &= \frac{\Delta \dot{E}_{\text{mech, fluid}}}{\dot{W}_{\text{shaft, in}}} = \frac{\dot{m} V_2^2 / 2}{\dot{W}_{\text{shaft, in}}} \\ &= \frac{(0.506 \text{ kg/s})(12.1 \text{ m/s})^2 / 2}{50.0 \text{ W}} \\ &= 0.741 \end{aligned}$$

FIGURE 2–60

The mechanical efficiency of a fan is the ratio of the rate of increase of the mechanical energy of air to the mechanical power input.

$$\eta_{\text{motor}} = \frac{\text{Mechanical power output}}{\text{Electric power input}} = \frac{\dot{W}_{\text{shaft,out}}}{\dot{W}_{\text{elect,in}}}$$

Pump
efficiency

$$\eta_{\text{generator}} = \frac{\text{Electric power output}}{\text{Mechanical power input}} = \frac{\dot{W}_{\text{elect,out}}}{\dot{W}_{\text{shaft,in}}}$$

Generator
efficiency

$$\eta_{\text{pump-motor}} = \eta_{\text{pump}}\eta_{\text{motor}} = \frac{\dot{W}_{\text{pump,u}}}{\dot{W}_{\text{elect,in}}} = \frac{\Delta\dot{E}_{\text{mech,fluid}}}{\dot{W}_{\text{elect,in}}}$$

Pump-Motor
overall efficiency

$$\eta_{\text{turbine-gen}} = \eta_{\text{turbine}}\eta_{\text{generator}} = \frac{\dot{W}_{\text{elect,out}}}{\dot{W}_{\text{turbine,e}}} = \frac{\dot{W}_{\text{elect,out}}}{|\Delta\dot{E}_{\text{mech,fluid}}|}$$

Turbine-Generator
overall efficiency

$$\eta_{\text{turbine}} = 0.75$$

$$\eta_{\text{generator}} = 0.97$$

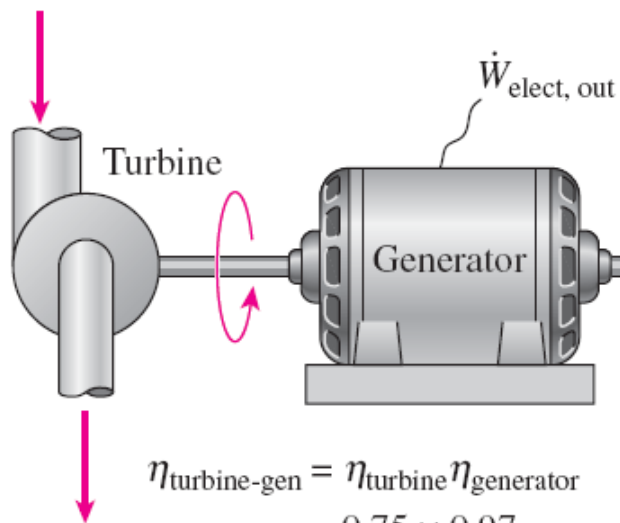

$$\begin{aligned}\eta_{\text{turbine-gen}} &= \eta_{\text{turbine}}\eta_{\text{generator}} \\ &= 0.75 \times 0.97 \\ &= 0.73\end{aligned}$$

FIGURE 2-61

The overall efficiency of a turbine-generator is the product of the efficiency of the turbine and the efficiency of the generator, and represents the fraction of the mechanical power of the fluid converted to electrical power.

ENERGY AND ENVIRONMENT

- The conversion of energy from one form to another often affects the environment and the air we breathe in many ways, and thus the study of energy is not complete without considering its impact on the environment.
- Pollutants emitted during the combustion of fossil fuels are responsible for **smog, acid rain**, and **global warming**.
- The environmental pollution has reached such high levels that it became a serious threat to **vegetation, wild life**, and **human health**.



Energy conversion processes are often accompanied by environmental pollution.

Ozone and Smog

- **Smog**: Made up mostly of ground-level ozone (O_3), but it also contains numerous other chemicals, including carbon monoxide (CO), particulate matter such as soot and dust, volatile organic compounds (VOCs) such as benzene, butane, and other hydrocarbons.
- **Hydrocarbons** and **nitrogen oxides** react in the presence of sunlight on hot calm days to form ground-level ozone.
- **Ozone** irritates eyes and damages the air sacs in the lungs where oxygen and carbon dioxide are exchanged, causing eventual hardening of this soft and spongy tissue.
- It also causes shortness of breath, wheezing, fatigue, headaches, and nausea, and aggravates respiratory problems such as asthma.

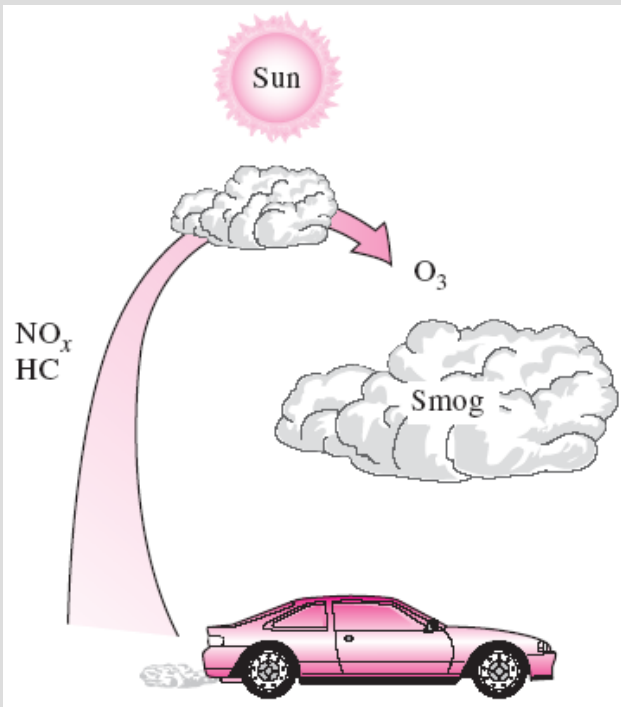

- The other serious pollutant in smog is **carbon monoxide**, which is a colorless, odorless, poisonous gas.
- It is mostly emitted by motor vehicles.
- It deprives the body's organs from getting enough oxygen by binding with the red blood cells that would otherwise carry oxygen. It is fatal at high levels.
- Suspended **particulate matter** such as **dust** and **soot** are emitted by vehicles and industrial facilities. Such particles irritate the eyes and the lungs.

Ground-level ozone, which is the primary component of smog, forms when HC and NO_x react in the presence of sunlight in hot calm days.

Acid Rain

- The sulfur in the fuel reacts with oxygen to form sulfur dioxide (SO_2), which is an air pollutant.
- The main source of SO_2 is the electric power plants that burn high-sulfur coal.
- Motor vehicles also contribute to SO_2 emissions since gasoline and diesel fuel also contain small amounts of sulfur.

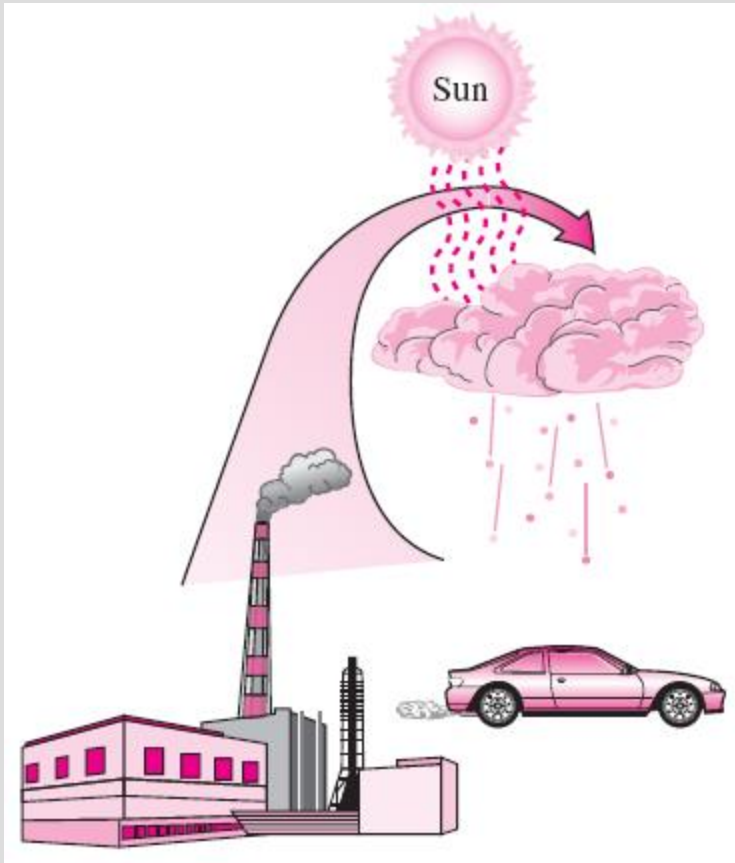

- The sulfur oxides and nitric oxides react with water vapor and other chemicals high in the atmosphere in the presence of sunlight to form sulfuric and nitric acids.
- The acids formed usually dissolve in the suspended water droplets in clouds or fog.
- These acid-laden droplets, which can be as acidic as lemon juice, are washed from the air on to the soil by rain or snow. This is known as **acid rain**.

Sulfuric acid and **nitric acid** are formed when sulfur oxides and nitric oxides react with water vapor and other chemicals high in the atmosphere in the presence of sunlight.

The Greenhouse Effect: Global Warming and Climate Change

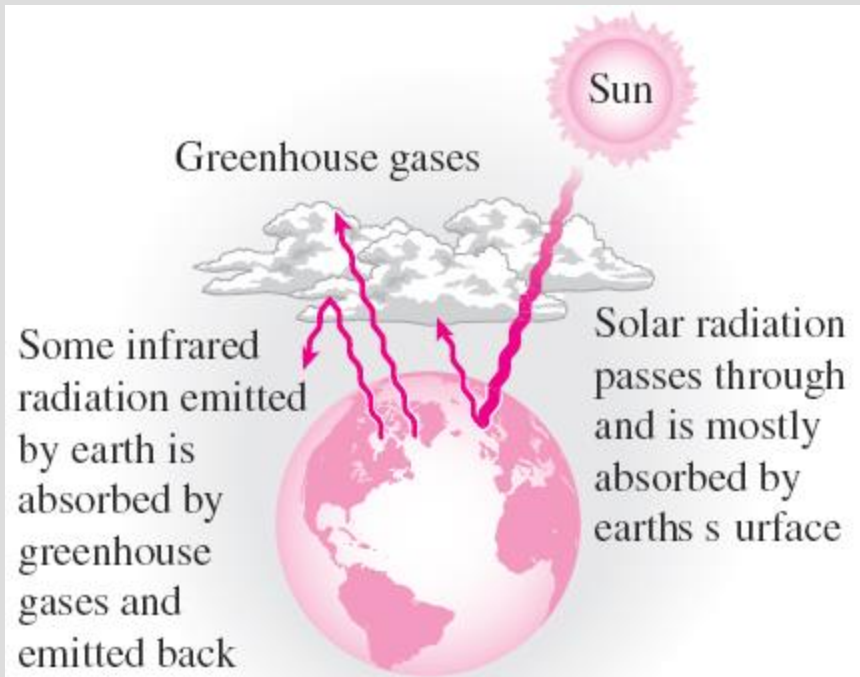

FIGURE 2-68

The greenhouse effect on earth.

- **Greenhouse effect:** Glass allows the solar radiation to enter freely but blocks the infrared radiation emitted by the interior surfaces. This causes a rise in the interior temperature as a result of the thermal energy buildup in a space (i.e., car).

The surface of the earth, which warms up during the day as a result of the absorption of solar energy, cools down at night by radiating part of its energy into deep space as infrared radiation.

Carbon dioxide (CO₂), water vapor, and trace amounts of some other gases such as methane and nitrogen oxides act like a blanket and keep the earth warm at night by blocking the heat radiated from the earth. The result is **global warming**.

These gases are called “**greenhouse gases**,” with CO₂ being the primary component.

CO₂ is produced by the burning of fossil fuels such as **coal, oil, and natural gas**.

- **A 1995 report:** The earth has already warmed about **0.5°C** during the last century, and they estimate that the earth's temperature will rise another **2°C** by the year 2100.
- A rise of this magnitude can cause **severe changes in weather patterns** with storms and heavy rains and flooding at some parts and drought in others, major floods due to the melting of ice at the poles, loss of wetlands and coastal areas due to rising sea levels, and other negative results.
- **Improved energy efficiency, energy conservation, and using renewable energy sources** help minimize global warming.



The average car produces several times its weight in CO₂ every year (it is driven 20,000 km a year, consumes 2300 liters of gasoline, and produces 2.5 kg of CO₂ per liter).



FIGURE 2-70

Renewable energies such as wind are called “green energy” since they emit no pollutants or greenhouse gases.

Summary

- Forms of energy
 - ✓ Macroscopic = kinetic + potential
 - ✓ Microscopic = Internal energy (sensible + latent + chemical + nuclear)
- Energy transfer by heat
- Energy transfer by work
- Mechanical forms of work
- The first law of thermodynamics
 - ✓ Energy balance
 - ✓ Energy change of a system
 - ✓ Mechanisms of energy transfer (heat, work, mass flow)
- Energy conversion efficiencies
 - ✓ Efficiencies of mechanical and electrical devices (turbines, pumps)
- Energy and environment
 - ✓ Ozone and smog
 - ✓ Acid rain
 - ✓ The Greenhouse effect: Global warming and climate change